

DILLON®

Force Control Switches

Simple and ultra-reliable passive sensors provide switch contacts that open or close at your specified loads.

- Overload protection
- Slack-line detection
- Up to four switches on a single device



DynaSwitch® and Cranegard®

DynaSwitch®

For cable ends and supported loads

Dillon DynaSwitch systems are a reliable, low cost way to control forces and prevent overloads. They can be used in automation controls, acting as scales. They can be used on cranes, hoists and elevators—not only to shut off power when an overload condition exists, but they can also be set to operate lights, buzzers or klaxons to warn of an impending overload. Like 24-hour sentinels, they can operate in normal or extreme environments.

The heart of the system is a force beam which operates in tension or compression. Seven different load capacities are available. Switch and physical connection options are listed. Each beam can accommodate from one to four switches which can be set to operate as many as four different switching functions or combinations including slackline detection.

All DynaSwitch force beams and attachment fittings have an ultimate safety factor of 5:1 (4.5:1 for metric capacities). In addition, all models have an overload stop or bolt to provide extra protection to the measuring ability of the DynaSwitch force beam. Dillon will set the switches to trigger at the loads you desire, if specified at time of order.

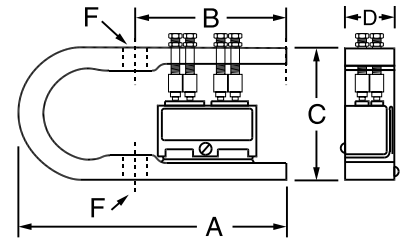

100 lb, 1,000 lb and 5,000 lb capacity force beam. Illustrated above with four low differential switches.

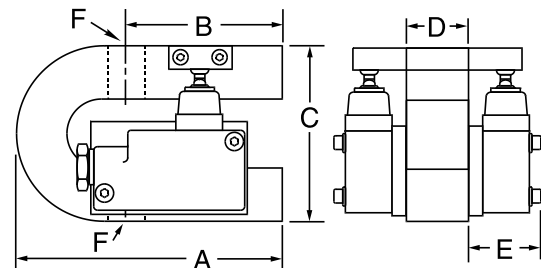

2,000 lb and 10,000 lb capacity force beam. Illustrated above with two weatherproof switches (option 2B).

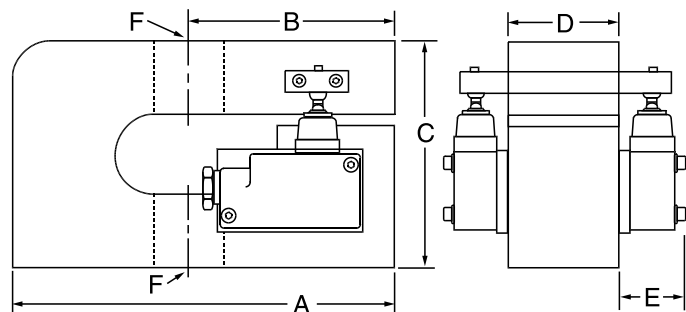

25,000 lb and 50,000 lb capacity force beam. Illustrated above with two weatherproof switches (option 2B).

Basic Force Beam

Model number	DSW-1	DSW-2	DSW-3	DSW-4	DSW-5	DSW-6	DSW-7
Capacity lb (kg)	100 (50)	1,000 (500)	2,000 (1000)	5,000 (2500)	10,000 (5000)	25,000 (12500)	50,000 (25000)
Min Setpoint* lb (kg)	15 (7.5)	100 (50)	200 (100)	500 (250)	1,000 (500)	1,250 (625)	2,500 (1250)
Repeatability lb (kg)	±3 (±1.5)	±30 (±15)	±60 (±30)	±150 (±75)	±300 (±150)	±750 (±375)	±1,500 (±750)
Hardware options	D,E,S	D,E,G,S	E,F,G,H,S	E,G,S	E,F,G,H,S	E,G,S	E,G
Switch options	A,J	A,J	B,C	A,J	B,C	B,C	B,C

Dimensions

A in (cm)	5.12 (13.0)	5.12 (13.0)	6.00 (15.2)	5.50 (14.0)	6.00 (15.2)	8.25 (21.0)	9.31 (23.7)
B in (cm)	2.94 (7.5)	2.94 (7.5)	3.50 (8.9)	3.00 (7.6)	3.50 (8.9)	5.00 (12.7)	5.00 (12.7)
C in (cm)	2.48 (6.3)	2.48 (6.3)	3.96 (10.1)	2.98 (7.6)	3.96 (10.1)	4.69 (11.9)	5.50 (14.0)
D in (cm)	0.98 (2.5)	0.98 (2.5)	1.47 (3.7)	0.98 (2.5)	1.44 (3.7)	2.38 (6.1)	2.68 (6.8)
E in (cm) Option B	n/a	n/a	1.59 (4.0)	n/a	1.59 (4.0)	1.59 (4.0)	1.59 (4.0)
E in (cm) Option C	n/a	n/a	n/a	n/a	2.48 (6.3)	2.48 (6.3)	2.48 (6.3)
F (thread)	1/4 - 28 UNF	1/2 - 20 UNF	7/8 - 14 UNF	1/2 - 20 UNF	7/8 - 14 UNF	1 1/4 - 12 UNF	1 3/4 - 12 UNF

* Multiply by 3 for Option C.

DynaSwitch® & Cranegard® Options

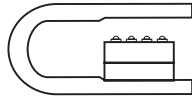

Option A Low differential travel switch

For use on DSW-1, DSW-2 and DSW-4 only.

For use in controlled environment. Single pole, double throw. 5 amps at 125 or 250 VAC. 12" leads included. Maximum 4 per unit. Operating temperature range: -65°F (-54°C) to 180°F (82°C)



Also a Cranegard option

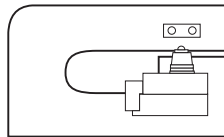

Option B Weatherproof low differential travel switch

For use on DSW-3, DSW-5, DSW-6, DSW-7 and Cranegard.

Has neoprene gasket around housing halves for tight seal. Includes elastomer seal boot around the actuator. Sealed conduit connectors. Die cast aluminum housing meets NEMA1 and 4 enclosures. Single pole, double throw, 0.002" travel. 15 amps, 125, 250, or 480 VAC. 1/4 amp, 250 VDC. Maximum 4 per unit. Switch thread size - 1/4, 3 1/2" threads minimum. Operating temperature range: -25°F (-32°C) to 160°F (71°C). Includes plastic cable strain relief.



Also a Cranegard option

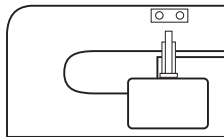

Option C Explosion-proof switch

For use on DSW-3, DSW-5, DSW-6, DSW-7 and Cranegard.

For use in hazardous locations (Class I, Div. I, groups C & D; Class II, groups E, F & G). Flame paths within the housing cool exploding gases below kindling temperature before they reach the explosive gases surrounding the housing. Single pole, double throw. Aluminum enclosure. (Not sealed against liquid.) UL and CSA listed. 20 amps, 125, 250, or 480 VAC. Maximum 2 per unit. Operating temperature range: -40°F (-40°C) to 160°F (71°C). Includes plastic cable strain relief.

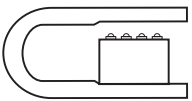
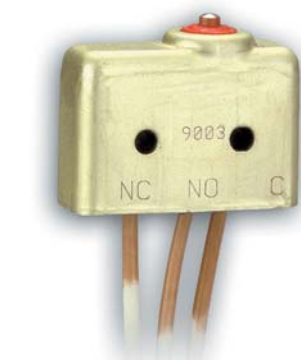

Option J Weatherproof low differential travel switch

For use on DSW-1, DSW-2 and DSW-4 only.

Sealed for use in high environment situations. Single pole, double throw. 5 amps at 125, 250 VAC. 12" leads included. Maximum 4 per unit. Operating temperature range: -65°F (-54°C) to 180°F (82°C)

Force control switch applications

Force control switches are used to protect cranes, hoists and other lifting machinery against weight or force overload as well as slack load. They are also used to perform control functions in the case of DynaSwitch. There are no dial indicators associated with these devices, only switches which not only shut off power when an overload condition exists, but also operate lights, buzzers or klaxons to warn of an impending overload.

One site for installation of a DynaSwitch is at the dead end of a line. If this is not practical, the DynaSwitch may be used to support an equalizer sheave, or an entire hoist may be suspended from the DynaSwitch.

The Cranegard clamps on to the line allowing it to be mounted where it is not possible to mount a DynaSwitch. No rope cutting is required.

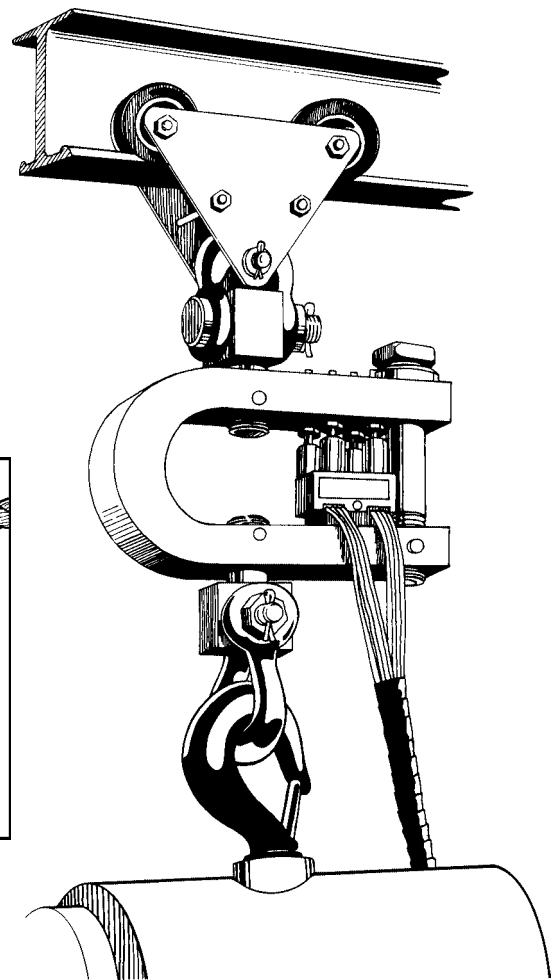
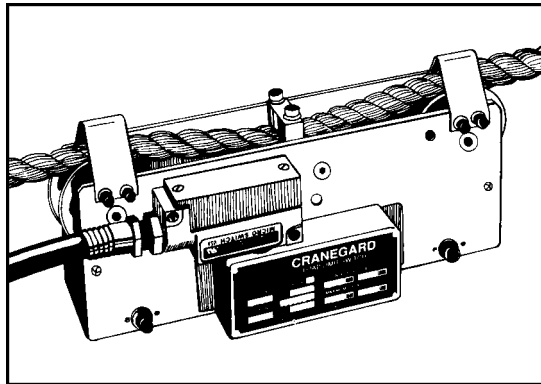

Ordering Information

When ordering DynaSwitches:

1. Specify model number.
2. Specify switch option and quantity.
3. Specify fitting option desired on top of force beam.
4. Specify fitting option desired on bottom of force beam.
5. Specify switch set point(s) if factory setting is desired.

Example: For a 10,000 lb range DynaSwitch with two weather proof switches, with lifting eye on top and shackle and adapter on bottom. Switch settings at 5,000 and 7,000 lb (both ascending).

Use this shortened form to designate models and options:

“DSW-5-B2-F-G

Switch settings at 5,000 lb (ascending) and 7,000 lb (ascending).”

When ordering Cranegards:

1. Specify Model number.
2. Specify pulley size (determined by rope diameter).
3. Specify switch option and quantity.
4. Specify switch set point(s) if factory setting is desired.

Example: For a 5,000 lb capacity unit with pulleys grooved for $\frac{5}{8}$ " rope diameter, with three weatherproof option B switches, set at 2,000, 3,000, and 4,000 lb

You may order in this fashion:

“CGS-2-B3

For $\frac{5}{8}$ " rope diameter

Switch settings at 2,000 lb (ascending), 3,000 lb (ascending) and 4,000 lb (ascending).”

Ascending loads are most common and are assumed if not stated. Descending loads are most frequently used for slack-line detection.

AUTHORIZED DISTRIBUTORS

Ask the experts. Dillon distributors offer complete service capabilities from application assistance to sales and product support. Their experienced representatives are the most knowledgeable experts that you will find in the force measurement industry. We recommend that you consult these capable specialists for all of your measuring needs.

Please call us or visit
www.dillon-force.com
for your nearest
Dillon distributor

DILLON

Overload Protection and
Overhead Weighing Equipment

Dillon/Quality Plus, Inc.
Distributor/Sales/Service/Calibration
Toll-Free: (800)493-2263
Fax: 816-453-7677
Email: sales@dqplus.com

www.dqplus.com



DynaSwitch® Hardware Options

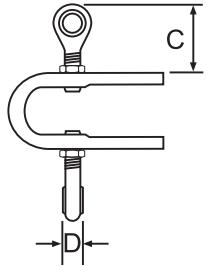
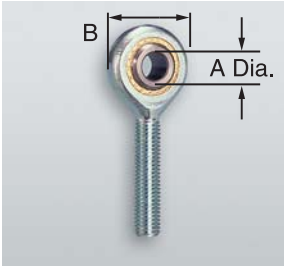

OPTION D For DSW-1 & DSW-2
Rod end connectors for tension rigging

Self-aligning, rod end connectors are normally mounted at right angles to each other providing universal alignment under load. They can be mounted parallel to the force beam on request.

Model	Dimensions inches (cm)			
	A	B	C	D
DSW-1	0.25 (.64)	0.75 (1.9)	1.25 (3.2)	0.38 (1.0)
DSW-2	0.50 (1.27)	1.32 (3.4)	1.88 (4.8)	0.63 (1.6)

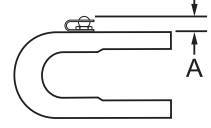

OPTION E For all capacity beams
Hardened ball and cup with retaining clip for compression use

Heat-treated alloy steel. Cup is highly polished and plated. Ball is held in place by spring clip held by shoulder of cup. Slightly different configuration for high range switches.

Models	DSW-1	DSW-3	DSW-6
	DSW-2	DSW-5	DSW-7
Dimension A in (cm)	0.45 (1.1)	0.61 (1.6)	0.83 2.1

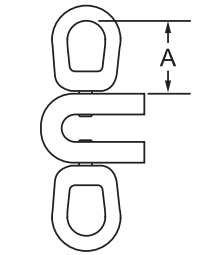

OPTION F For DSW-3 & DSW-5
Lifting eye for tension use

Hardened steel eye threads into force beam. Oriented parallel to force beam unless otherwise specified. Orientation fixed by roll pin.

Model & Switch	DSW-3		DSW-5	
	Option B	Option C	Option B	Option C
Dimension A in (cm)	4.34 (11.0)	5.24 (13.3)	4.34 (11.0)	5.06 (12.9)

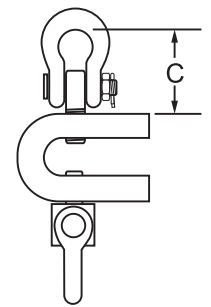
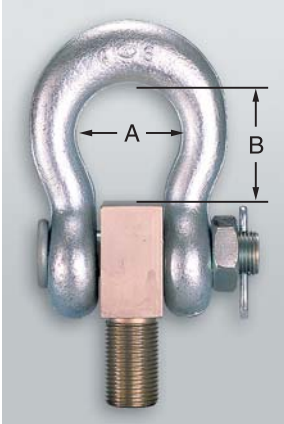

OPTION G
Adapter, shackle and pin

For all except DSW-1 & DSW-4. A hardened, forged steel shackle with adapter and pin for tension rigging of DynaSwitches. Shackles and similar fittings are installed at time of manufacture with the plane of the top fitting lifting opening parallel to the beam length, and at 90° to the position of bottom fitting. Orientation fixed by roll pin.

Model	DSW-2	DSW-3	DSW-4	DSW-5	DSW-6	DSW-7
Dimension A in (cm)	1.69 (4.3)	1.69 (4.3)	1.69 (4.3)	1.69 (4.3)	3.25 (8.2)	5.00 (12.7)
Dimension B in (cm)	1.94 (4.9)	1.94 (4.9)	1.94 (4.9)	1.94 (4.9)	4.06 (10.3)	6.12 (15.5)
Dimension C in (cm)	4.13 (10.5)	4.13* (10.5)*	4.19 (10.6)	4.13** (10.5)**	7.12*** (18.1)***	10.36 (26.3)

* Option C switch is 4.76 inch (12.1 cm)
** Option C switch is 5.06 inch (12.85 cm)
*** Option C switch is 8.38 inch (21.3 cm)

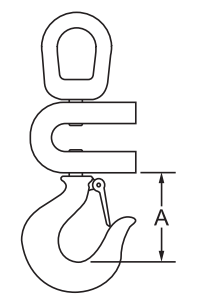
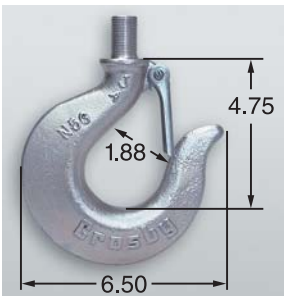

OPTION H For DSW-3 & DSW-5
Non-swiveling hook

A hardened forged steel hook threaded to fit the 2,000 and 10,000 load switches only. Has spring latch. Should be specified and installed at time of manufacture before set points are adjusted. Oriented parallel to force beam unless otherwise specified. Orientation fixed by roll pin.

Model & switch	DSW-3		DSW-5	
	Option B	Option C	Option B	Option C
Dimension A in (cm)	5.00 (12.7)	5.00 (12.7)	5.00 (12.7)	4.81 (12.2)

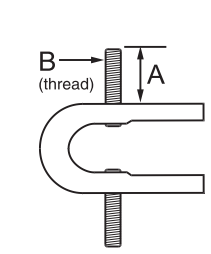

OPTION S For all except DSW-7
Threaded stud

For applications where conventional shackle or attachment eye cannot be used. Will accommodate yokes and other special fixtures. Heat treated alloy steel, secured by a roll pin.

Model	DSW-1	DSW-2	DSW-3	DSW-4	DSW-5	DSW-6
Dimension A in (cm)	1.25 (3.2)	1.88 (4.8)	2.19 (5.6)	2.31 (5.9)	2.19* (5.6)*	2.31 (5.9)
B (thread)	1/4-28	1/2-20	7/8-14	1/2-20	7/8-14	1 1/4-20

* Option C switch is 2.00 inch (5.1 cm)

Cranegard®

Clamp-on cable overload protection

Clamps on cables for wire rope hoist, elevator and crane overload prevention and slackline detection. Installs in minutes with screwdriver and Allen wrench.

Installation is simplicity itself. Clamp the Cranegard® directly onto a slack hoist or crane wire rope quickly without severing rope or interrupting service. Up to four switches can be furnished. Switch actuates immediately when pre-set load limit is exceeded.

Dillon will set the switches to trigger at the loads you desire, if specified at time of order.



Specifications Notes:

- * Specify rope diameter when ordering. Other rope diameters can be specified on special order.
- 1. Basic units can accommodate 1,2,3 or 4 of option B or 1 or 2 of option C switches
- 2. Ultimate safety factor of all units is 2:1 (1.8:1 for metric capacities)
- 3. Cable should be IWRC (Independent Wire Rope Core) with as many strands as possible.
- 4. Wire rope selection for any application for proper safety factor is a customer responsibility.
- 5. Calibration performed with rope diameter specified at order.

Basic Cranegard® Unit

Model	Capacity lb (kg)	Min. Set Point lb (kg)	Repeatability lb (kg)	Rope Diameter* inches (mm)
CGS-1	2,500 (1250)	100 (50)	±75 (±35)	³ / ₁₆ to ¹ / ₂ (5 to 13)
CGS-2	5,000 (2500)	200 (100)	±150 (±75)	³ / ₈ to ⁷ / ₈ (10 to 22)
CGS-3	10,000 (5000)	400 (200)	±300 (±150)	⁷ / ₁₆ to ⁷ / ₈ (11 to 22)
CGS-4	20,000 (10000)	800 (400)	±600 (±300)	⁵ / ₈ to 1 ¹ / ₄ (16 to 32)

Dimensions

Model	Switch Option	Width in (cm)	Height in (cm)	Length in (cm)
CGS-1	1B, 2B	3.6 (9.2)	5.4 (13.7)	11.5 (29.2)
	CGS-2	3B 4B		
CGS-3	1C	5.0 (12.7)	6.0 (15.2)	
	2C	7.3 (18.4)		
CGS-4	1B, 2B	4.5 (11.4)	7.8 (19.7)	16.0 (40.6)
	3B, 3B	5.4 (13.7)		
	1C	5.9 (14.9)		
	2C	8.0 (20.3)		